

LCD MODULE

SPECIFICATION

| | |
|-----------------|------------------------|
| Model: | LCM-UE046VQ-RB40-L001A |
| Version: | V1.0 |
| Date: | 20221023 |

Customer Confirmation 客户确认

| Approved by | Notes |
|-------------|-------|
| | |

Please return one of the copies of the specification with your signature to us within two weeks after you receive this document. If it is not returned, we will assume that you agree to the entire contents of this specification document.

请贵司在收到规格书的两周内，将签好字的规格书原件或者复印件寄回。如果没有返回，我司将会认为贵司已经默认接受产品规格书中的全部资料和规范。

VIEWE Confirmation 优奕确认

| Prepared by | Reviewed by | Approved by |
|-------------|-------------|-------------|
| | | |



REVISION HISTORY

| Revision 版本号 | Date 日期 | Contents of Revision Change 修改内容 | Remark 备注 |
|-----------------|------------|-------------------------------------|--------------|
| V1.0 | 2022.10.23 | Preliminary release | |
| | | | |
| | | | |
| | | | |
| | | | |
| | | | |
| | | | |
| | | | |
| | | | |
| | | | |
| | | | |
| | | | |
| | | | |
| | | | |
| | | | |
| | | | |
| | | | |
| | | | |
| | | | |

SHENZHEN VIEWE TECHNOLOGY CO., LTD

TABLE of CONTENTS

| | |
|---|-----------|
| 1. GENERAL INFORMATION | 4 |
| 1.1 Features | 4 |
| 1.2 Mechanical Specification | 4 |
| 2. ABSOLUTE MAXIMUM RATINGS | 5 |
| 3. DC ELECTRICAL CHARACTERISTICS | 5 |
| 3.1 Driving TFT LCD Panel | 5 |
| 3.2 Backlight Characteristics | 5 |
| 4. TIMING CHARACTERISTICS | 6 |
| 5. RESET TIMING | 8 |
| 6. EXTERNAL DIMENSIONS | 9 |
| 7. INTERFACE SIGNAL | 10 |
| 8. ELECTRO-OPTICAL CHARACTERISTICS | 11 |
| 9. RELIABILITY | 13 |
| 12. PACKAGE DRAWING | 20 |



1. GENERAL INFORMATION

1.1 Features

- 1) Pixel Arrangement: RGB Vertical Stripe
- 2) Interface Mode: 3SPI-RGB 18bits
- 3) Driver IC: ST7701S or Equivalent
- 4) Operation Temperature: -20~70°C
- 5) Storage Temperature: -30~80°C
- 6) Backlight Type: White LED
- 7) Display mode: Normally Black
- 8) LED life time: 30,000 Hours

1.2 Mechanical Specification

| Item 项目 | Specification 规格 | Unit 单位 | Remark 备注 |
|--------------------------|----------------------------|-------------------|--------------|
| Pixel Driving element | A-Si TFT | - | |
| Screen Size | 4.58 | Inch | Diagonal |
| Resolution | 320(W)*3(RGB)*960(H) | Dots | |
| Interface | 3SPI_RGB 18bits | - | 40PIN |
| Module Power Consumption | TBD | Watt | Typ. |
| Active Area | 36.77 (H)* 110.30 (V) | mm | |
| Module Size (W*H*D) | 41.57 (H)*118.8 (V)*2.5(D) | mm | |
| Luminance | 300 | cd/m ² | Typ. |
| Viewing Direction | All | O'clock | - |
| Display Color | 16.7M | Colors | 18bits |



2. ABSOLUTE MAXIMUM RATINGS

| Parameter | Symbol | Min | Max | Unit | Note |
|----------------------------|-----------|------|-----------|------|------|
| Power Supply voltage 1 | VCI~GND | -0.3 | +4.6 | V | |
| Power Supply voltage 2 | IOVCC~GND | -0.3 | +4.6 | V | |
| Logic Input Voltage Range | VIN | -0.3 | IOVCC+0.5 | V | |
| Logic Output Voltage Range | VO | -0.3 | IOVCC+0.5 | V | |
| Operating temperature | Topr | -20 | +70 | °C | |
| Storage temperature | Tstg | -30 | +80 | °C | |

* The absolute maximum rating values of this product are not allowed to be exceeded at any times. Should a module be used with any of the absolute maximum ratings exceeded, the characteristics of the module may not be recovered, or in an extreme case, the module may be permanently destroyed.

3. DC ELECTRICAL CHARACTERISTICS

3.1 Driving TFT LCD Panel

AGND = GND = 0V, Ta = 25C

| Parameter | Symbol | Min | Typ | Max | Unit |
|-----------------------------------|--------|-----------|-----|-----------|------|
| Supply voltage for analog circuit | VCI | 2.5 | 2.8 | 3.6 | V |
| Supply voltage for logic circuit | IOVCC | 2.5 | 2.8 | 3.6 | V |
| Input voltage 'H'level | VIH | 0.7*IOVCC | — | IOVCC | V |
| Input voltage 'L'level | VIL | GND | — | 0.3*IOVCC | V |
| Output voltage 'H'level | VOH | 0.8*IOVCC | — | IOVCC | V |
| Output voltage 'L'level | VOL | GND | — | 0.2*IOVCC | V |

3.2 Backlight Characteristics

Ta = 25C

| Item | Symbol | Min | Typ | Max | Unit | Condition |
|-----------------|--------|-------------------|------|-----|-------|-----------|
| Forward voltage | Vf | - | 12.8 | | V | If=40 |
| Luminance | LV | | 8000 | — | cd/m | mA |
| Number of LED | - | 4X2 | | | Piece | - |
| Connection mode | S/P | 4Serial/2Parallel | | | - | - |

Using condition: constant current driving method If= 2×20mA (+/-10%)

4. TIMING CHARACTERISTICS

4.1 Serial Interface Characteristics(3-line serial)

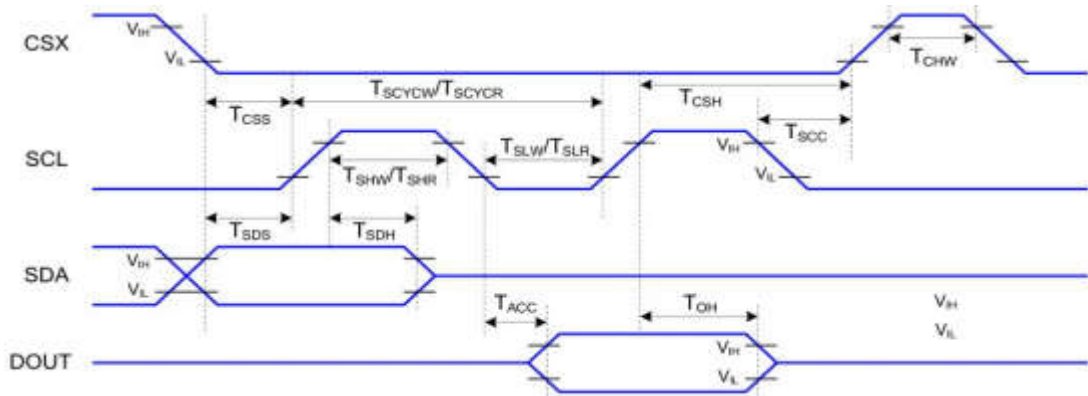

Figure 4.1 3-line serial Interface Timing Characteristics

T_a=25°C, IOVCC=1.65~3.7V, VCC=2.5~3.7V

| Signal | Symbol | Parameter | Min | Max | Unit | Description |
|--------------|--------------------|-------------------------------|-----|-----|------|--------------------------------|
| CSX | T _{CSS} | Chip select setup time(write) | 15 | - | ns | |
| | T _{CSH} | Chip select hold time(write) | 15 | - | ns | |
| | T _{CSS} | Chip select setup time(read) | 60 | - | ns | |
| | T _{SCC} | Chip Select hold time(read) | 60 | - | ns | |
| | T _{CHW} | Chip Select 'H' pulse width | 40 | - | ns | |
| SCL | T _{SCYCW} | Serial clock cycle(write) | 66 | - | ns | Write Command & Data Ram |
| | T _{SHW} | SCL 'H' pulse width(write) | 15 | - | ns | |
| | T _{SLW} | SCL 'L' pulse width(write) | 15 | - | ns | |
| | T _{SCYCR} | Serial clock cycle(read) | 150 | - | ns | Read Command & Data Ram |
| | T _{SHR} | SCL 'H' pulse width(read) | 60 | - | ns | |
| | T _{SLR} | SCL 'L' pulse width(read) | 60 | - | ns | |
| SDA (DIN) | T _{SDS} | Data setup time | 10 | - | ns | |
| | T _{SDH} | Data hold time | 10 | - | ns | |

Note : The rising time and falling time (Tr, Tf) of input signal are specified at 15 ns or less. Logic high and low levels are specified as 30% and 70% of IOVCC for Input signals.

Table 4.1 3-line Serial Interface Characteristics

4.2 RGB Interface Characteristics

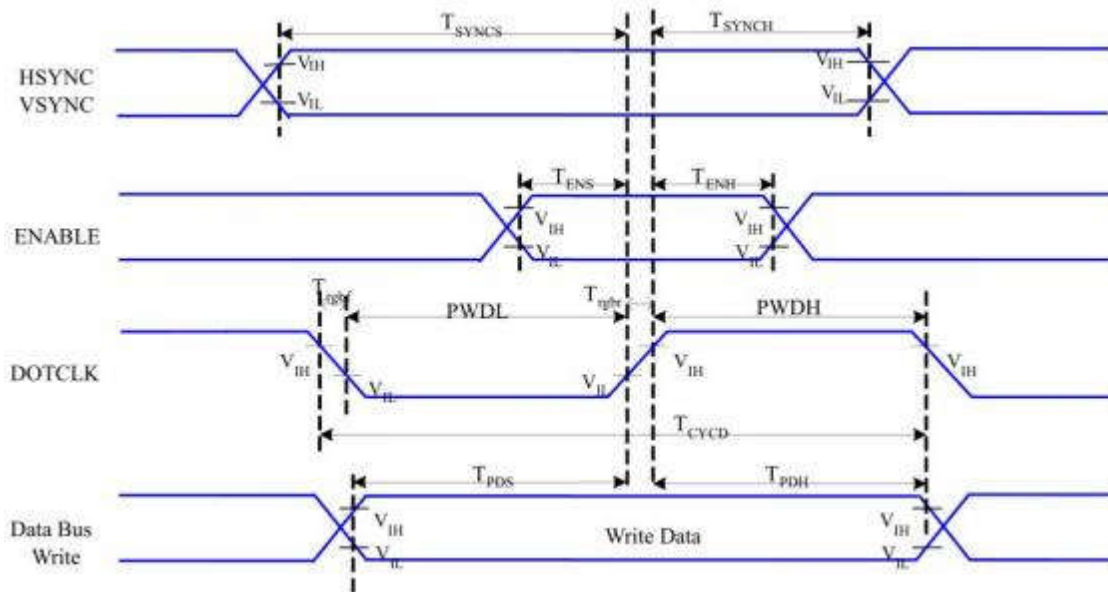

Figure 4.2.1 RGB Interface Timing Characteristics

$T_a=25C, IOVCC=1.8V, VCC=2.8V$

| Signal | Symbol | Parameter | Min | Max | Unit | Description |
|--------------|----------------------|-------------------------------|-----|-----|------|-------------|
| HSYNC, VSYNC | TSYNCS | VSYNC,HSYNNV Setup Time | 5 | - | ns | |
| ENABLE | TENS | Enable setup time | 5 | - | ns | |
| | TENH | Enable hold time | 5 | - | ns | |
| DOTCLK | PWDH | DOTCLK High-level Pulse Width | 15 | - | ns | |
| | PWDL | DOTCLK Low-level Pulse Width | 15 | - | ns | |
| | TCYCD | DOTCLK Cycle Time | 33 | - | ns | |
| | T_{rghr}, T_{rgfh} | DOTCLK Rise/Fall time. | - | 15 | ns | |
| DB | TPDS | PD Data Setup Time | 5 | - | ns | |
| | TPDH | PD Data Hold Time | 5 | - | ns | |

Table 4.2.2 18/16 Bits RGB Interface Timing Characteristics

5. Reset Timing

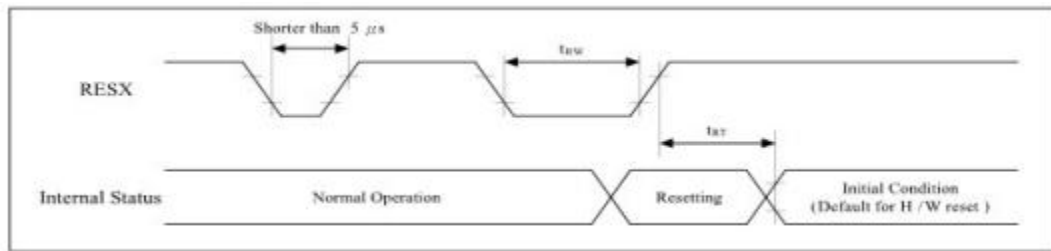

| Signal | Symbol | Parameter | Min. | Max. | Unit |
|--------|-----------|----------------------|----------|-----------|------|
| RESX | t_{low} | Reset pulse duration | 10(Note) | - | us |
| | t_{tr} | Reset cancel | - | 10(Note) | ms |
| | | | - | 120(Note) | ms |

Notes:

1. The reset cancel also includes required time for loading ID bytes, VCOM setting and other settings from EEPROM (or similar device) to registers.

This loading is done every time when there is HW reset cancel time (t_{TR}) within 10 ms after a rising edge of RESX.

2. Spike due to an electrostatic discharge on RESX line does not cause irregular system reset according to the table below :

| RESX Pulse | Action |
|---------------------|----------------|
| Shorter than 5us | Reset Rejected |
| Longer than 9us | Reset |
| Between 5us and 9us | Reset starts |

3. During the Resetting period, the display will be blanked(The display is entering blanking sequence, which maximum time is 120 ms, when Reset

Starts at Sleep-Out status. The display remains the blank state in Sleep-In mode). Then return to Default condition for Hardware Reset

4. Spike Rejection also applies during a valid reset pulse as shown below :

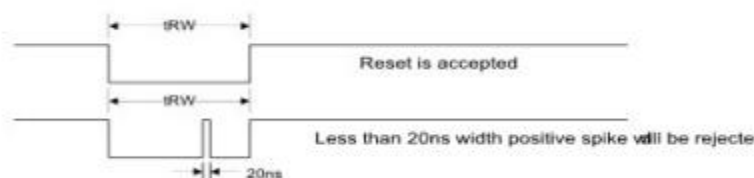

5. When Reset applied during Sleep-In Mode.

6. When Reset applied during Sleep-Out Mode

7. It is necessary to wait 10ms after releasing RESX before sending commands. Also Sleep Out command cannot be sent for 120 ms.

6. EXTERNAL DIMENSIONS

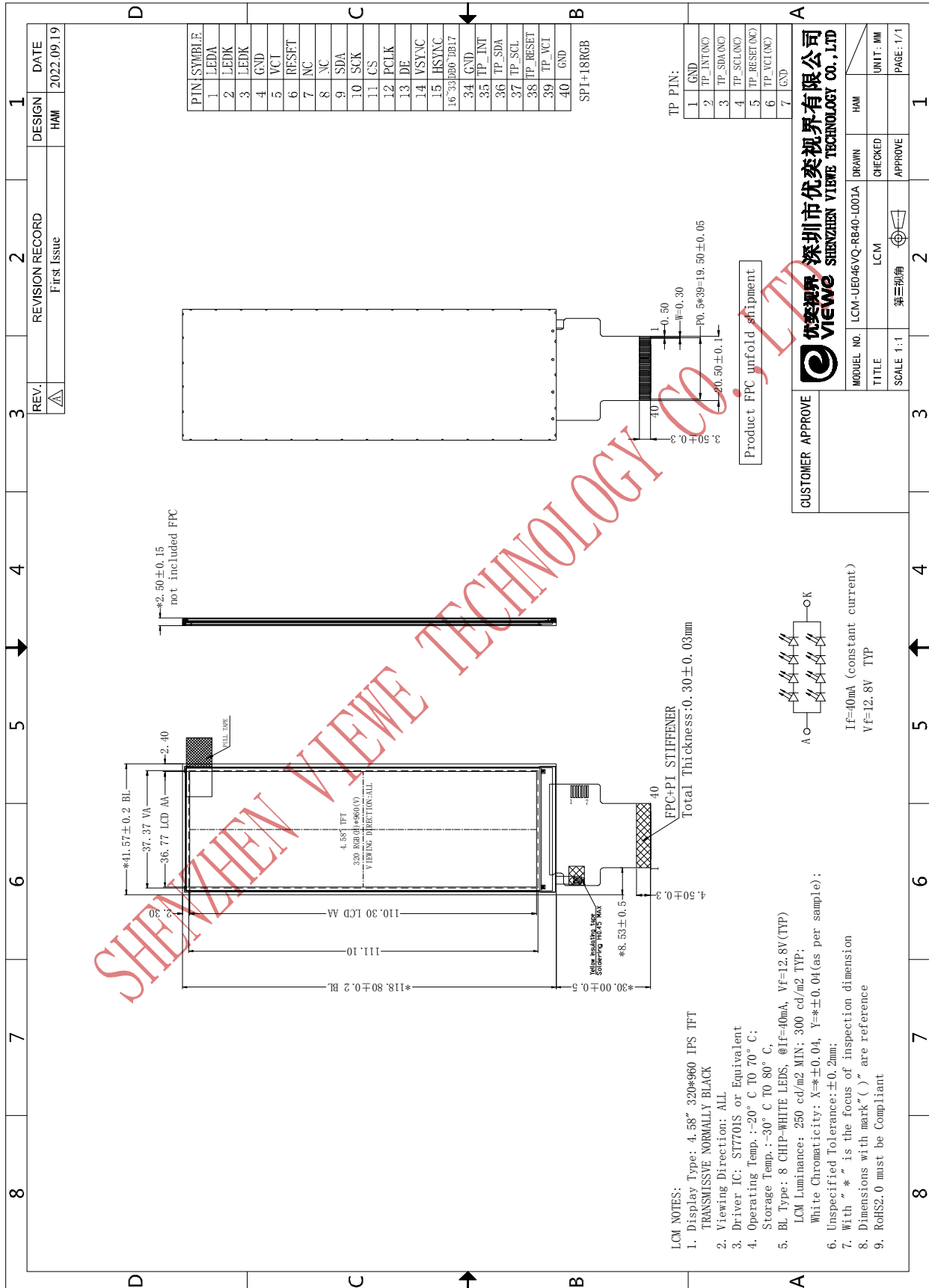



7. INTERFACE SIGNAL

| Pin No. | Symbol | Description |
|---------|----------|--|
| 1 | LEDA | LED backlight anode |
| 2 | LEDK | LED backlight cathode |
| 3 | LEDK | LED backlight cathode |
| 4 | GND | Power ground |
| 5 | VCC | Analog power supply |
| 6 | RESET | Reset signal(low active) |
| 7 | NC | NC |
| 8 | NC | NC |
| 9 | SDA | Serial data input pin in serial bus system interface |
| 10 | SCK | Pixel clock signal input pin |
| 11 | CS | Chip select |
| 12 | PCLK | Pixel clock signal in RGB interface |
| 13 | DE | Data enable signal in RGB I/F mode |
| 14 | VSYNC | Vertical synchronizing signal input pin |
| 15 | HSYNC | Horizontal synchronizing signal input pin |
| 16~33 | DB0~DB17 | RGB data signal (DB0:BLUE LSB;DB5:BLUE MSB;DB6:GREEN LSB;DB11:GREEN MSB;DB12:RED LSB;DB17:RED MSB) |
| 34 | GND | Power ground |
| 35 | TP_INT | INT pin for CTP |
| 36 | TP_SDA | SDA pin for CTP |
| 37 | TP_SCL | SCL pin for CTP |
| 38 | TP_RESET | Reset pin for CTP |
| 39 | TP_VCI | Power supply for CTP |
| 40 | GND | Power ground |

8. ELECTRO-OPTICAL CHARACTERISTICS

| Item | Symbol | Condition | Min | Typ | Max | Unit | Note |
|-------------------------------|--------------------|--|-----------------|-------|-------|------|------|
| Transmittance (w/o polarizer) | T% | $\theta=0^\circ$ $T_a=25^\circ\text{C}$ | -- | 5.7 | - | % | 1 |
| Contrast ratio | Cr | | 1000 | 1200 | - | - | 3 |
| Response time | Ton+Toff | | - | 25 | 35 | ms | 4 |
| Surface Luminance | LV | | | 300 | | cd/m | 2 |
| Viewing angle range | H or V er | Θ_{x+} | | 80 | - | deg | 5 |
| | | Θ_{x-} | | 80 | - | deg | |
| | | Θ_{Y+} | Center CR>10 | 80 | - | deg | |
| | | Θ_{Y-} | 80 | - | deg | | |
| CIE(x,y) chromaticity | Red | x | 0.627 | 0.647 | 0.667 | - | 6 |
| | | y | 0.292 | 0.312 | 0.332 | - | |
| | Green | x | 0.241 | 0.261 | 0.281 | - | |
| | | y | 0.545 | 0.565 | 0.585 | - | |
| | Blue | x | 0.117 | 0.137 | 0.157 | - | |
| | | y | 0.090 | 0.110 | 0.130 | - | |
| | White | x | 0.27 | 0.30 | 0.33 | - | |
| | | y | 0.29 | 0.33 | 0.36 | - | |

Note 1. Ambient condition : $25^\circ\text{C}\pm 2^\circ\text{C}$, $60\pm 10\%\text{RH}$, under 10 Lux in the darkroom。 Note 2. Measure device: BM-7A (TOPCON), viewing cone= 2°

L_y = Average Surface Luminance with all white pixels (P1,P2,P3,P4,P5)

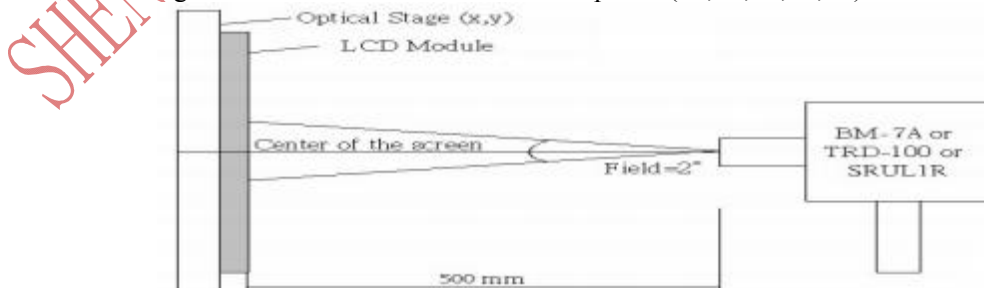

Note 3. Definition of Contrast Ratio:

$$CR = \frac{\text{Average Surface Luminance with all black pixels (P1,P2,P3,P4,P5)}}{\text{Average Surface Luminance with all white pixels (P1,P2,P3,P4,P5)}}$$

Note 4. Definition of Response Time (Ton, Toff), The response time is defined as the time interval between the 10% and 90% amplitudes.

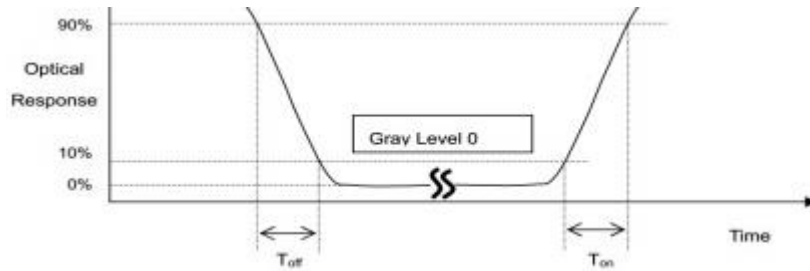

Note 5. Definition of view angle(θ , ψ):

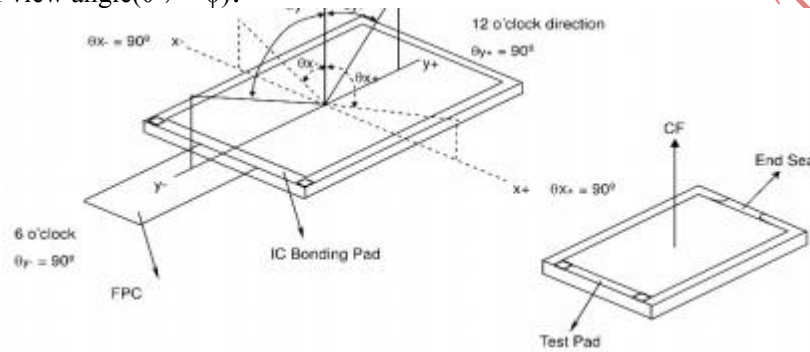

Note 6. The LCD module should be stabilized at a given temperature for 20 minutes to avoid abrupt temperature change during measuring. In order to stabilize the luminance, the measurement should be executed after lighting Backlight for 20 minutes in a windless room. Measuring method for Contrast ratio, surface luminance, Luminance uniformity, CIE(x,y) chromaticity.

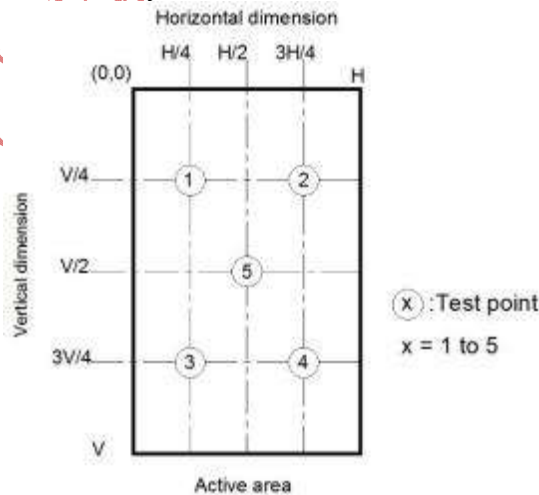

Light spot size $\square = 7\text{mm}$, 500mm distance from the LCD surface to detector lens measurement instrument is TOPCON's luminance meter BM-7

9. RELIABILITY

| Item 项目 | Test Condition 测试条件 | Remark 备注 |
|--|--|--------------|
| High Temperature Storage | Ta =+80°C / 96Hours | Note1,2,3 |
| Low Temperature Storage | Ta =-30°C / 96Hours | Note1,2,3 |
| High Temperature Operating | Ta =+70°C / 96Hours | Note1,2,3 |
| Low Temperature Operating | Ta =-20°C / 96Hours | Note1,2,3 |
| Temperature Cycle storage Test | -30°C/30min Δ+70°C /30min for 30cycles, Transfer time less than 5min | Note2,3 |
| Thermal humidity storage Test | 80°C x 90%RH / 96Hours | Note2,3 |
| Package Vibration Test | Frequency: 10Hz~55Hz, Amplitude:1.5mm, 1 hrs for each direction of X, Y, Z | Note2 |
| Packing shock test | Drop to the ground from 60cm height, 1 corner, 3 edges, 6 surfaces. | Note2 |
| ESD test | Contact: ±4KV Air: ±8KV | ESD |
| Inspection after Test: Note1: Ta is the ambient temperature of samples. Note 2: In the standard condition, there shall be no practical problem that may affect the display function. After the reliability test, the product only guarantees operation, but doesn't guarantee all the cosmetic specification. Note 3: Before cosmetic and function tests, the product must have enough recovery time, at least 2 hours at room temperature. | | |

10. INSPECTION CRITERION

This specification is made to be used as the standard acceptance/rejection criteria for Normal LCM Product.

1 Sample plan

Sampling plan according to GB/T2828.1-2003/ISO 2859- 1: 1999 and ANSI/ASQC Z1.4-1993,normal level 2 and based on:

Major defect: AQL 0.65

Minor defect: AQL 1.0

2. Inspection condition

Viewing distance for cosmetic inspection is about 30cm with bare eyes, and under an environment of 20~40W light intensity, all directions for inspecting the sample should be within 45° against perpendicular line. (Normal temperature 20~25°C and normal humidity 60±15%RH).

3. Definition of inspection zone in LCD.

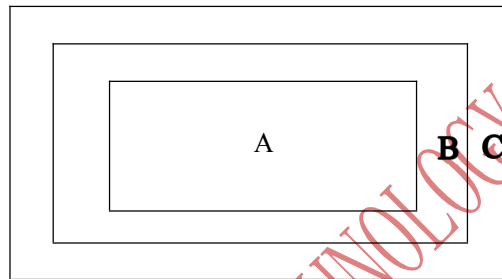

Zone A: character/Digit area

Zone B: viewing area except Zone A (Zone A + Zone B=minimum Viewing area) Zone C: Outside viewing area (invisible area after assembly in customer's product) Fig.1 Inspection zones in an LCD.

Note: As a general rule, visual defects in Zone C are permissible, when it is no trouble for quality and assembly of customer's product.

4.Standards of inspection items



4.1 Major Defect

| Item No | Items to be inspected | Inspection Standard | Classification of defects |
|---------|------------------------|--|---------------------------|
| 4.1.1 | All functional defects | 1.No display | Major |
| | | 2.Display abnormally | |
| | | 3.Missing vertical , horizontal segment | |
| | | 4.Short circuit | |
| | | 5. Back-light no lighting, flickering and abnormal lighting | |
| 4.1.2 | Missing | Missing component | |
| 4.1.3 | Outline dimension | Overall outline dimension beyond the drawing is not allowed. | |
| 4.1.4 | linearity | No more than 1.5% | |

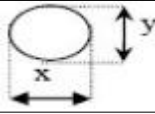
4.2 Cosmetic Defect

| Item No | Items to be inspected | Inspection Standard | | | Classification of defects | |
|--|--|---|--------|-------|---------------------------|---|
| 4.2.1 | Clear Spots Black and white Spot defect Pinhole, Foreign Particle, polarizer Dirt | For dark/white spot, size Φ is defined as $\Phi=(x + y)/2$  | | | Minor | |
| | | 1 | | | | |
| | | Acceptable Qty | | | | |
| | | Zone | A | B | | C |
| | | Size(mm) | | | | |
| | | $\Phi \leq 0.15$ | Ignore | | | |
| | | $0.15 < \Phi \leq 0.20$ | 2 | | | |
| | $0.20 < \Phi \leq 0.30$ | 1 | | | | |
| | $\Phi > 0.30$ | 0 | | | | |
| | Clear Spots TP Dirt | 2 | | | Minor | |
| | | Acceptable Qty | | | | |
| | | Zone | A | B | | C |
| | | Size(mm) | | | | |
| | | $\Phi \leq 0.15$ | Ignore | | | |
| | | $0.15 < \Phi \leq 0.20$ | 2 | | | |
| $0.20 < \Phi \leq 0.30$ | | 1 | | | | |
| $\Phi > 0.30$ | 0 | | | | | |
| Dim Spots Circle shaped and dim edged defects | 3 | | | Minor | | |
| | Acceptable Qty | | | | | |
| | Zone | A | B | | C | |
| | Size(mm) | | | | | |
| | $\Phi \leq 0.2$ | Ignore | | | | |
| | $0.20 < \Phi \leq 0.40$ | 2 | | | | |
| $0.40 < \Phi \leq 0.60$ | 1 | | | | | |
| $\Phi > 0.60$ | 0 | | | | | |

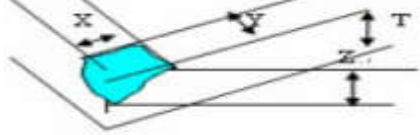
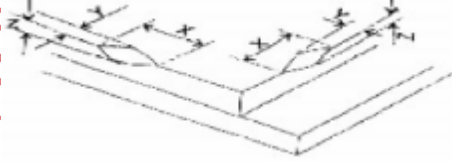
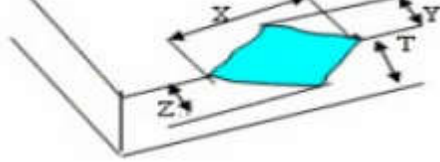
| Item No | Items to be inspected | Inspection Standard | | | | | Classification of defects |
|---------------|--|--|----------------------|----------------|----------------|--------|---------------------------|
| 4.2.2 | Line defect Black line, White line, Foreign material on polarizer | Size(mm) | | Acceptable Qty | | | Minor |
| | | L(Length) | W(Width) | Zone | | | |
| | | | | A | B | C | |
| | | Ignore | $W \leq 0.05$ | Ignore | | | |
| | | $L \leq 5.0$ | $0.05 < W \leq 0.08$ | 2 | | | |
| | | | $W > 0.08$ | 0 | | | |
| 4.2.2 | Foreign material on TP film | The line can be seen after mobile phone in the operating condition: | | | | | Minor |
| | | Size(mm) | | Acceptable Qty | | | |
| | | L(Length) | W(Width) | Zone | | | |
| | | | | A | B | C | |
| | | Ignore | $W \leq 0.05$ | Ignore | | | |
| | | $L \leq 5.0$ | $0.05 < W \leq 0.08$ | 3 | | | |
| | $W > 0.08$ | 0 | | | | | |
| 4.2.3 | Dim line defect Polarizer scratch TP film scratch | If the scratch can be seen after mobile phone cover assembling or in the operating condition, judge by the line defect of 4.2.2. If the scratch can be seen only in non-operating condition or some special angle, judge by the following. | | | | | Minor |
| | | Size(mm) | | Acceptable Qty | | | |
| | | L(Length) | W(Width) | Zone | | | |
| | | | | A | B | C | |
| | | Ignore | $W \leq 0.03$ | Ignore | | | |
| | | $5.0 < L \leq 10.0$ | $0.03 < W \leq 0.05$ | 2 | | | |
| $L \leq 5.0$ | $0.05 < W \leq 0.08$ | 1 | | | | | |
| | $W > 0.08$ | 0 | | | | | |
| 4.2.4 | Polarize Air bubble | Air bubbles between glass & polarizer | | | | | Minor |
| | | Size(mm) | Zone | | Acceptable Qty | | |
| | | | A | B | C | | |
| | | $\Phi \leq 0.20$ | Ignore | | | Ignore | |
| | | $0.20 < \Phi \leq 0.3$ | 2 | | | | |
| $\Phi > 0.30$ | 0 | | | | | | |

| Item No | Items to be inspected | Inspection Standard | | | Classification of defects |
|--|-----------------------|---|--------------------------------|-----------|---------------------------|
| 4.35 | Glass defect | (i) Chips on corner A:LCD Glass defect  | | | Minor |
| | | X(mm) | Y(mm) | Z(mm) | |
| | | ≤3.0 | ≤3.0 | Disregard | |
| | | Notes: S=contact pad length Chips on the corner of terminal shall not be allowed to extend into the ITO pad or expose perimeter seal. B:TP Glass defect | | | |
| | |  | | | |
| | | X(mm) | Y(mm) | Z(mm) | |
| | | ≤3.0 | ≤3.0 | Disregard | |
| | | (ii) Usual surface cracks A:LCD Glass defect | | | |
| | |  | | | |
| | | X(mm) | Y(mm) | Z(mm) | |
| | | ≤3.0 | <Inner border line of the seal | Disregard | |
| | | B:TP Glass defect | | | |
|  | | | | | |
| X(mm) | Y(mm) | Z(mm) | | | |
| ≤6.0 | <2.0 | Disregard | | | |
| (iii) Crack Cracks tend to break are not allowed. | | | | | |
|  | | | | | |

11. PRECAUTIONS FOR USE OF LCD MODULES

1. Handling Precautions

- (1) The display panel is made of glass and polarizer. As glass is fragile. It tends to become or chipped during handling especially on the edges. Please avoid dropping or jarring. Do not subject it to a mechanical shock by dropping it or impact.
- (2) If the display panel is damaged and the liquid crystal substance leaks out, be sure not to get any in your mouth. If the substance contacts your skin or clothes, wash it off using soap and water.
- (3) Do not apply excessive force to the display surface or the adjoining areas since this may cause the color tone to vary. Do not touch the display with bare hands. This will stain the display area and degraded insulation between terminals (some cosmetics are determined to the polarizer).
- (4) The polarizer covering the display surface of the LCD module is soft and easily scratched. Handle this polarizer carefully. Do not touch, push or rub the exposed polarizers with anything harder than an HB pencil lead (glass, tweezers, etc.). Do not put or attach anything on the display area to avoid leaving marks on. Condensation on the surface and contact with terminals due to cold will damage, stain or dirty the polarizer. After products are tested at low temperature they must be warmed up in a container before coming is contacting with room temperature air.
- (5) If the display surface becomes contaminated, breathe on the surface and gently wipe it with a soft dry cloth. If it is heavily contaminated, moisten cloth with one of the following solvents
 - Isopropyl alcohol
 - Ethyl alcoholDo not scrub hard to avoid damaging the display surface.
- (6) Solvents other than those above-mentioned may damage the polarizer. Especially, do not use the following.
 - Water
 - Ketone
 - Aromatic solventsWipe off saliva or water drops immediately, contact with water over a long period of time may cause deformation or color fading. Avoid contacting oil and fats.
- (7) Exercise care to minimize corrosion of the electrode. Corrosion of the electrodes is accelerated by water droplets, moisture condensation or a current flow in a high-humidity environment.
- (8) Install the LCD Module by using the mounting holes. When mounting the LCD module make sure it is free of twisting, warping and distortion. In particular, do not forcibly pull or bend the I/O cable or the backlight cable.
- (9) Do not attempt to disassemble or process the LCD module.
- (10) NC terminal should be open. Do not connect anything.
- (11) If the logic circuit power is off, do not apply the input signals.



(12) Electro-Static Discharge Control , Since this module uses a CMOS LSI, the same careful attention should be paid to electrostatic discharge as for an ordinary CMOS IC. To prevent destruction of the elements by static electricity, be careful to maintain an optimum work environment.

- Before remove LCM from its packing case or incorporating it into a set, be sure the module and your body have the same electric potential. Be sure to ground the body when handling the LCD modules.
- Tools required for assembling, such as soldering irons, must be properly grounded. Make certain the AC power source for the soldering iron does not leak. When using an electric screwdriver to attach LCM, the screwdriver should be of ground potentiality to minimize as much as possible any transmission of electromagnetic waves produced sparks coming from the commutator of the motor.
- To reduce the amount of static electricity generated, do not conduct assembling and other work under dry conditions. To reduce the generation of static electricity be careful that the air in the work is not too dried. A relative humidity of 50%-60% is recommended. As far as possible make the electric potential of your work clothes and that of the work bench the ground potential
- The LCD module is coated with a film to protect the display surface. Exercise care when peeling off this protective film since static electricity may be generated

(13) Since LCM has been assembled and adjusted with a high degree of precision, avoid applying excessive shocks to the module or making any alterations or modifications to it.

- Do not alter, modify or change the shape of the tab on the metal frame.
- Do not make extra holes on the printed circuit board, modify its shape or change the positions of components to be attached.
- Do not damage or modify the pattern writing on the printed circuit board.
- Absolutely do not modify the zebra rubber strip (conductive rubber) or heat seal connector.
- Except for soldering the interface, do not make any alterations or modifications with a soldering iron.
- Do not drop, bend or twist LCM.

2. Storage precautions

2.1 When storing the LCD modules, avoid exposure to direct sunlight or to the light of fluorescent lamps.

2.2 The LCD modules should be stored under the storage temperature range. If the LCD modules will be stored for a long time, the recommend condition is:

Temperature : 0C ~ 40C Relatively humidity: ≤80%

2.3 The LCD modules should be stored in the room without acid, alkali and harmful gas.

2.4 The LCD modules should be no falling and violent shocking during transportation, and also should avoid excessive press, water, damp and sunshine.

12. PACKAGE DRAWING

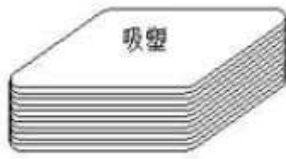

第一步

将产品放入吸塑盘中，
LCD AA 面朝上，注意
防呆方向

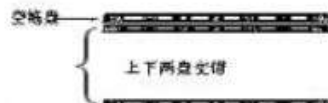

第二步

每一层吸塑盘与相邻
层，叠放时相错 180
度，最上层不放产品，
总叠加层数参考

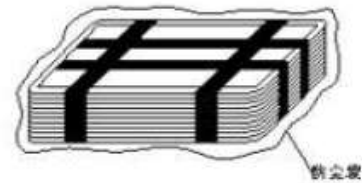

第三步

检查无误后用胶带固
定吸塑盘，将捆好的吸
塑盘放入无尘带中并
封口；

First step

Putting products into the
tray,
LCD A.A faces Upward,
(pay attention to the

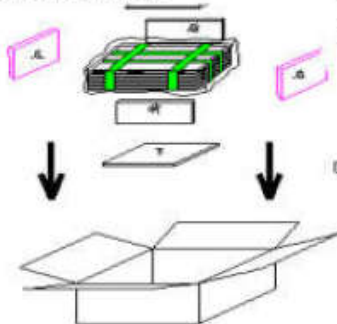

第四步

外箱内侧底部和四周
放上泡棉将包好的产
品装入纸箱，合盖；

Fourth step

Putting EPE foams and
products with trays into
the carton;
Close the carton box

Second step

Neighbouring trays should be
staggered 180° while stacking
up.
on the top, there is an empty
tray without product



第五步

最后胶带封箱，贴外箱
标签

fifth step

Sealing the carton with
cellulose tape ;
Stick on a carton label,

Third step

Taping up the tray
after inspection, and
put them into a PE

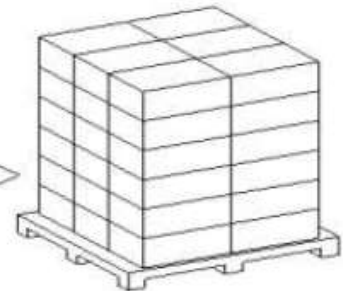

第六步

将每箱整齐放在栈板
上并包裹最高可堆叠 6
层)

sixth step

Placing the boxes together
on a pallet (6 layers at
most),